

Hanging Trapeze Bars™

SINGLE SECTION TRAPEZE BARS



CUSTOM TRAPEZE BARS

Sizes, diameters, end caps can be customized.

Simply Hem Graphics
 top and bottom for aluminum tubes.

Features:

- Strong and lightweight
- Very easy to use
- Extremely economical
- Clear satin anodized finish
- Shipped one set per polybag

SOLD AS A TOP CROSSBAR AND
 BOTTOM CROSSBAR SET

Steel eyebolts are included for top crossbars.

Aluminum alloy tubes,
 etched and clear anodized finish.

SINGLE SECTION TRAPEZE BARS

Model	Banner Width	Diameter
BP01	18"	7/8"
BP02	22"	7/8"
BP03	24"	7/8"
BP04	28"	7/8"
BP05	36"	7/8"
BP06	48"	7/8"
BP07	60"	7/8"
BP08	72"	7/8"
BP011	84"	* 7/8"
BP013	96"	* 7/8"

*Has 3rd Eyebolt in center, banner notch required.

Standard Configuration

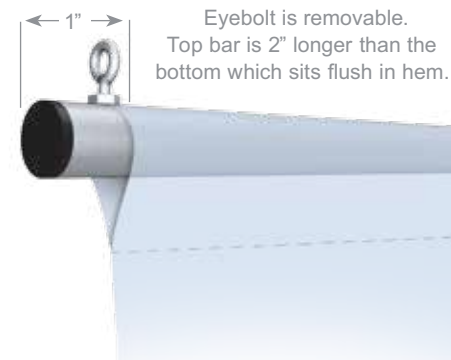

Eyebolt is removable.
 Top bar is 2" longer than the
 bottom which sits flush in hem.

Optional Configuration

Specify: **SD** Side Eyebolts
 Same cost as standard configuration.
 Ordering Example: **BP06SD**



BABY TRAPEZE BAR WIRE SETS

3/16" diameter steel wire. Tops have loops
 at each end. Bottoms are straight cut.

Model	Width	Model	Width
BPW09	9"	BPW18	18"
BPW12	12"	BPW24	24"

Hanging Trapeze Bars™

MULTIPLE SECTION TRAPEZE BARS

Simply Hem Graphics
 top and bottom for aluminum tubes.

- Strong and lightweight
- Very easy to use
- Extremely economical
- Clear satin anodized finish

SOLD AS A TOP CROSSBAR AND
 BOTTOM CROSSBAR SET

Steel eyebolts are included for top crossbars.

Standard Configuration

Top Bar is 2" longer than bottom bar,
 which sits flush inside bottom hem.

Optional Configuration

Specify: **SD** Side Eyebolts
 Same cost as standard configuration.

Models	Banner Width	Sections	Diameter	# Eyebolts
BP09	96"	2	1-1/4"	3
BP10	120"	2	1-1/4"	3
BP12	144"	2	1-1/4"	3
BP15	180"	3	1-1/4"	4
BP20	240"	4	1-1/4"	5

CUSTOM SIZES AVAILABLE.

Disclaimer:

We recommend getting samples and fully testing these products for your application. Purchaser determines suitability of all product usage and assumes all risk & liability. Neither the seller nor the manufacturer shall be held liable for any injury, loss or damage from use of such product.



Multiple section units connect with solid aluminum turned bushings.

Wall Mount Trapeze Bar™ Bracket Sets

WALL MOUNT BRACKET SETS

Wall mount bracket sets work in conjunction with our optional configuration **SD** Trapeze Bars, pages 64 & 65, ie. those with top bars having side threads.

Simply remove eyebolts from Trapeze Bars and discard (or order without). Brackets attach to top bar only, bottom bar drops freely.

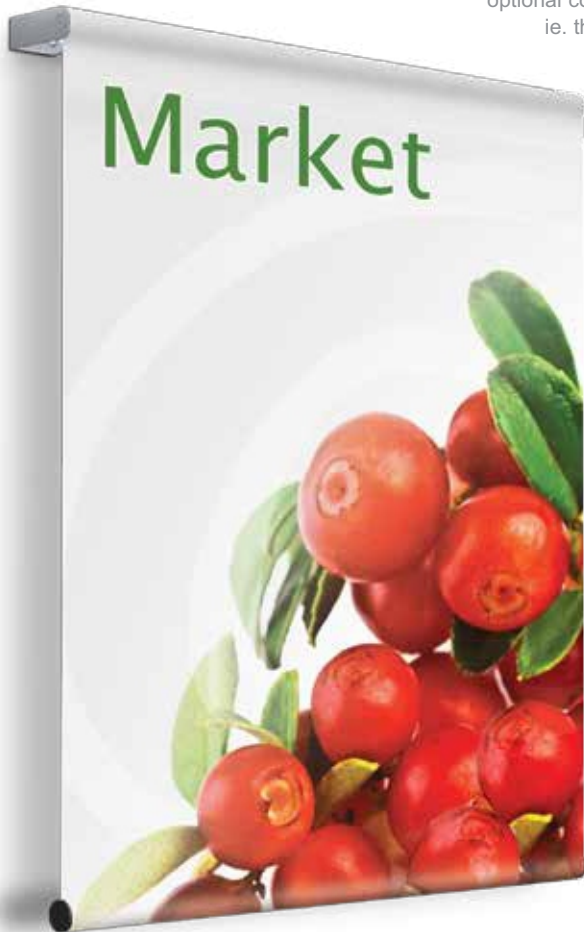

BPSB1- For single section Trapeze Bars (7/8" diameter).

BPMB1- For 2 section Trapeze Bars BP09SD BP10SD& BP12SD

BPMB2- For 3 section Trapeze Bars BP15SD

BPMB3- For 4 section Trapeze Bars BP20SD

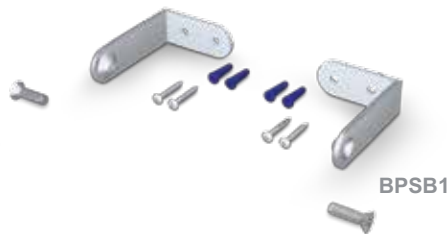

BPSB1

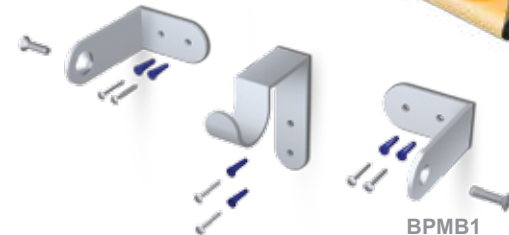

BPMB1

SIMPLE GRAPHIC HANGING SOLUTIONS!

J Hook Trapeze System™

GRAPHIC CHANGEOUTS WITHOUT A LADDER



Combining Trapeze Bars & SnapGraphic Grippers.
Facilitate graphic changes to be extremely associate friendly.
Extremely cost efficient, layouts are offered on a project basis.

Telescopic Changeout Pole

JBT1 Two sections - opens - 10' Extension / 15' Ceiling.

JBT2 Three sections - opens - 15' Extension / 20' Ceiling.

Hanging Banner Kits

HANGING DOWEL KITS

Includes: (2) aluminum 1/2" diameter dowels, end caps and (1) diamond braided cord. Use banners with a hem top & bottom, put nail into wall and you're good to go.

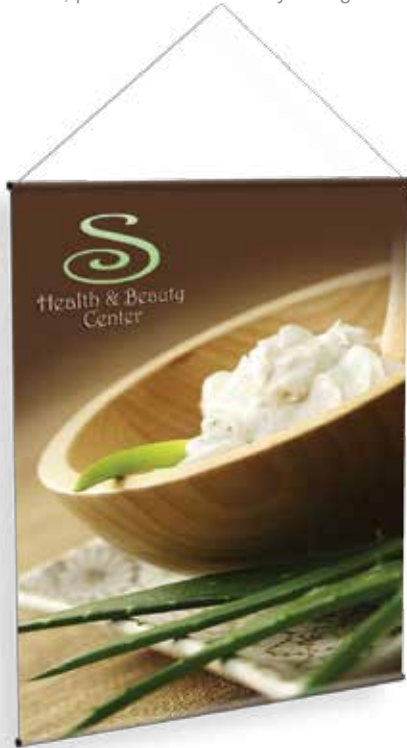

Choose Model and Color*

PP24	24" wide dowels
PP36	36" wide dowels
PP48	48" wide dowels

WALLMOUNTSNAPBARKITS

Includes: (2) Aluminum Snap Bars, matte anodized finish. Strong springs hold graphics in place. Black endcaps (4) wall screws & anchors.



Choose Model and Color*

MEB1	18"	MEB5	36"
MEB2	22"	MEB6	48"
MEB3	24"	MEB7	60"
MEB4	28"	MEB8	72"

-S Satin Silver **-B** Matte Black

*Does not affect price, but must use to order.

WALL MOUNT BANNER KITS

Includes: (2) 3/4" diameter matte anodized poles and (2) 3-1/4" round plates with mounting holes. Wall hardware not included.



Choose Model and Color*

WB1	12" Banner Width
WB2	18" Banner Width
WB3	22" Banner Width
WB4	24" Banner Width
WB5	30" Banner Width

Visual Merchandising Clamps

SOLID ALUMINUM SIGNING CLAMPS

- Solid aluminum alloy
- 2" w x 3" h, rubber grips
- Anodized satin finishes
- Clever binder spring
- Grip range up to 1/2" thick.

Specify: -S Satin Silver -B Matte Black

VCDP



VCWM



(2) VCTP

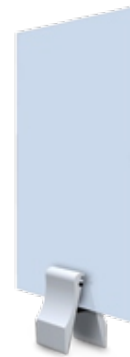

VCCD



VCDP

Steel grid clip, telescopic aluminum tube assembly 20"-36"



VCTP

Clamp only, use on table top, or for small signs.



VCSW

Clamp with integral slot wall bracket included.



VCCO

360° swivel, snaps onto poles, Diameter: 1" -1, 1-1/2" -3, 3/4" -5, 1-1/4" -7.



VCCD

Clamp has integral eye hook for ceiling drops.



VCMT

Clamp with male 1/4-20 thread, multifunctional.



VCWM

Features hole for mounting parallel on a wall.

TO PLACE AN ORDER CALL 757-593-8580 OR EMAIL: SALES@DDISIGNS.COM



Ceiling Anchors, Links & Cables

Ceiling Anchors

Swivel Clip

Clear plastic clip for ceiling grids, swivels 360°. Sold 10/per. **ANC01**.

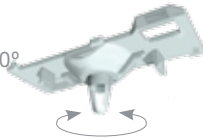

Metal Threaded Studs

Strong heavy duty scissors clip. Use to mount threaded accessories. Sold 10/per. **ANC14**.



Grid Snap On Swivel Hook

1/4" hook slot rotates 360°. Sides simply snap on. White. Sold 10/per. **ANC02**.



Steel Spring Stud

Clips onto grid, thread for accessories. Sold 10/per. **ANC13**.

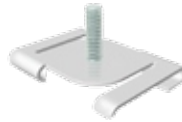

Grid Snap On Eye

3/8" diameter eye. Great looking. Simple & strong. Sold 10/per. **ANC03**.



Ceiling Twist Loop

7/8" loop, 2" base. Quick connect, just twist. White. Sold 10/per. **ANC06**.



Metal Loop

Strong steel spring. Provides 15/64" loop. Sold 10/per. **ANC04**.



Clear Hinged Hook

One piece hook hinges open & closes around ceiling grid. Sold 10/per. **ANC05**.



Suction Cups

Clear 2-14" diameter with hanging hook. Sold 100/per. **ANC18**



Round Magnetic Bases

Plated steel case and hook house powerful magnets.



Suction Cup with push tack. Clear 2-1/4" diameter Sold 100/per. **ANC19**



Model	O.D.	Rating
RMB1	1-1/2"	18 lbs.
RMB2	2"	20 lbs.
RMB3	2-1/2"	38 lbs.

Links

Links Sold 100/per.

CLK1 C Link 1-1/12" long
CLK2 C Link 3" long
SHK1 S Link 1" long
SHK2 S Link 1-5/8" long



Rings

Set of 4, hold graphics with holes or grommets.
RG3 2" Diameter
RG5 3" Diameter



Double C Hooks

Plated steel hangwires. Economical. Holds up to 10 lbs. Sold 50/per.

Order: **HDC4, HDC6, HDC12**, etc.



4"
6"
12"
18"
24"
36"

Double Loop Cable

1/32" uncoated stainless steel with 1/2" long loops. Hold up to 50 lbs. Sold 2/per.

HDL6 6" **HDL12** 12"

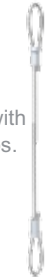

Adjustable Cable Assemblies

Wire rope loop one side, straight wire other, plus an adjustable spring loaded cable lock. Choice of locks - Diecast zinc and double barrel steel. Simply feed cable through the lock and adjust to required length. Sold 2/per.

Model	Lock	Gauge	Length	Rating
ADC136	Diecast	1/32"	6'	14 lbs.
ADC1312	Diecast	1/32"	12'	14 lbs.
ADC1318	Diecast	1/32"	18'	14 lbs.
ADC166	Diecast	1/16"	6'	50 lbs.
ADC1612	Diecast	1/16"	12'	50 lbs.
ADC1618	Diecast	1/16"	18'	50 lbs.
ABS166	Steel	1/16"	6'	50 lbs.
ABS1612	Steel	1/16"	12'	50 lbs.
ABS1618	Steel	1/16"	18'	50 lbs.



Adjustable Cable Locks (without cable)
 Use with bare **uncoated** wire rope only.

ADC13	Diecast	1/32"
ADC16	Diecast	1/16"
ABS16	Steel	1/16"



Diecast Lock



Steel Lock

Mounts, Cable, Harnesses & Tapes

Snap-on Graphic Clips (2/set)
Holds rigid media up to 3/32" thick.

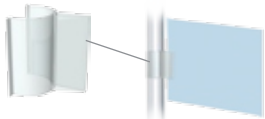

HT1	Fits 1" diam. uprights
HT2	Fits 3/4" diam. uprights
HT3	Fits 1-1/2" diam. & SignPost

French Cleat

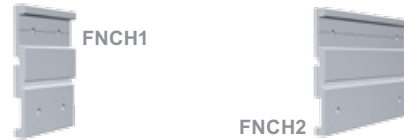

Set of 2 interlocking French Cleats. 4 screws & wall anchors included. Anchor 1 piece to wall other to object.

FNCH1	2"	FNCH3	12"
FNCH2	4"	FNCH4	22"

Grid Ceiling Divider



GRCD1 for positioning anchors & signage in the best possible location. 24" long, white, compatible for most grid ceilings.

Ceiling Tracks



White aluminum bars with mounting holes. Mounting hardware not included. **CTK48** 48", 3 holes, **CTK96** 96", 5 holes.



Harness Sets

Harness Sets should be professionally installed.

- HRNS33** 3 small shackles, 3 double loop lead wires (specify length), collection shackle, 20' pendant wire, 2 wire rope clips.
- HRNS4** 4 small shackles, 4 double loop lead wires (specify length), collection shackle, 20' pendant wire, 2 wire rope clips.
- HRNS5** 5 small shackles, 5 double loop lead wires (specify length), collection shackle, 20' pendant wire, 2 wire rope clips.



Forged eyebolts, shackles, quick links, aircraft cable.

Fully test every installation as conditions vary, and neither the manufacturer nor the sales representative may be held liable for injury or loss or damage resulting from the use of these products.



Uncoated
HWB32100 100'

Wire Rope Aircraft quality galvanized.
100' rolls.

Model	Gauge	Style	Rated
HWB32100	1/32"	Bare Uncoated	14 lb.
HWB16100	1/16"	Bare Uncoated	50 lb.

DWSC132 Oval crimp sleeves. For 1/32" 50/per.
DWSC116 Oval crimp sleeves. For 1/16" 50/per.



CTWBC Crimping tool.

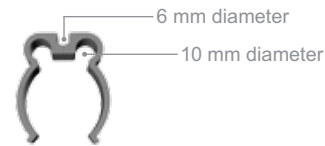

Wire Management Clips

Holds 6mm & 10mm cables. (set of 4).

CRWO	for 1" to 1-1/2" tubes
CRWM	for SignPost & Creo

Flexible Magnet



Flexible magnet 1" wide
3/32" thick high tack
adhesive. 100' roll. **MGT2**.

Magnetic Receptive Tape



OGMRS - Magnetic receptive tape
.025" x 1" 100 feet with pressure
sensitive adhesive.

Two-sided Removable Tape



Roll of white foam tape with
removable adhesive on 2 sides.
1/32" thick, 1" wide, 30' long. **GXTP1**

Removable Foam Strips



White, each strip is 1/2" x 2" long
and each has a load capacity of 3 lbs.
Pull tab sideways to remove.
Packed 36. **RFT1**